

Turbo EC

Inline mixed-flow fans with EC motor

Use

- Designed for supply and exhaust ventilation systems requiring high energy efficiency, excellent response, high pressure and air flow rate while keeping noise under control – such as high-humidity commercial and industrial spaces (e.g. bathrooms and kitchens) as well as flats, villas, shops and cafes.
- Compatible with air ducts from 100 to 315 mm in diameter.



Air flow:
up to 1970 m³/h
547 l/s



Power:
from 30 W



Noise level:
from 46 dBA



Design

- Turbo EC fans combine the versatility and outstanding performance of both axial and centrifugal fans producing a powerful air flow and high pressure while retaining the signature energy-efficiency and response of EC motors.
- The casing of Turbo EC fan is made of low-combustible polypropylene. The removable central unit with a motor, impeller and terminal box is attached to the fittings by means of special mounting brackets with integral latches. This helps to make the fan maintenance extremely simple and convenient. Fan service no longer requires major disassembly and dismantling of the fan: all you have to do is remove the main unit from the casing and carry out the maintenance as required.
- The inlet fitting has a profiled header which ensures smooth air flow into the fan. Conically shaped impeller with specially profiled blades cause circular velocity rise, that results in air flow boost and pressure increase comparing to conventional design.
- The fan outlet combination of a diffuser, specially designed impeller and rectifier allow for the optimum air distribution: high air capacity and pressure without excessive noise.

Motor

- High-efficient direct current EC motor.
- EC technology meets the up-to-date requirements to energy-saving and controllable ventilation and provides up to 35 % energy saving as compared to asynchronous motors.
- EC motor ensures totally controllable speed range for the fan and has integrated overheating protection with automatic restart.
- EC motor has no friction and wearing parts as capacitor and brushes. Instead a maintenance-free EC controller electronic circuit board is used.
- The impeller is dynamically balanced.
- The fan is compatible with 50 Hz and 60 Hz power mains and the maximum speed does not depend on power mains frequency.

Speed control

- The fan speed is controlled with a 0–10 V control signal from the following sources:
 - integrated or external speed controller
 - controller with sensors
 - central BMS system.
- The control signal value changes depending on air temperature, pressure, smoke concentration and other parameters.
- During signal value change the fan with EC motor correspondingly changes the rotations speed and delivers required air volume to the ventilation system.
- The computer central building management systems (BMS) enable integration of several EC motors in network and precise individual operation control for each fan.

Mounting

- The fans are intended for installation in matching diameter air ducts at any point of the ventilation system without limitation to mounting angle.
- The fan casing has a flat mounting plate for a secure wall mounting.
- Electrical connection and installation must be performed in accordance with the instruction manual and the electrical connections diagram applied to the terminal box.
- A single system may have several fans installed in parallel to boost the output capacity or in series to boost the working pressure.

Designation key

Series	Motor type	Duct diameter [mm]
Turbo	EC: electronically commutated motor	100; 125; 150; 160; 200; 250; 315

Accessories

Silencers	Filter boxes	Electric heaters	Water heaters	Backdraft air dampers	Air dampers	Clamps	Speed controllers
							
SD	KFBK / KFBT	EKH	WKH	VRV	VK / VKA	K	CDT E/0-10

Overall dimensions [mm]

Type	Ø D	Ø D1	B	H	L	Weight [kg]
Turbo EC 100	98	164	192	241	302.5	1.75
Turbo EC 125	123	164	193	241	258.5	2.15
Turbo EC 150	148	187	216.5	253.5	289	2.3
Turbo EC 160	158	187	216.5	253.5	289	3.25
Turbo EC 200	198	209	239	277.5	295.5	3.95
Turbo EC 250	247	257	288	339	383	7.8
Turbo EC 315	308.5	323	360	423	443	11.95

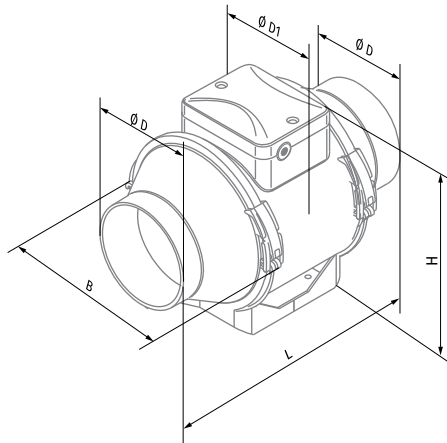

Technical data

Parameters	Turbo EC 100	Turbo EC 125	Turbo EC 150 (160)	Turbo EC 200	Turbo EC 250	Turbo EC 315
Voltage [V / 50-60 Hz]	1~ 230	1~ 230	1~ 230	1~ 230	1~ 230	1~ 230
Power [W]	30	40	55	123	169	284
Current [A]	0.29	0.37	0.48	1.02	1.38	1.25
Max. airflow [m³/h (l/s)]	300 (83)	450 (125)	600 (167)	1040 (289)	1285 (357)	1970 (547)
RPM [min⁻¹]	3680	3750	3390	3390	2870	2826
Sound pressure level at 3m [dBA]	47	49	46	49	53	55
Transported air temperature [°C]	-25...+55	-25...+55	-25...+55	-25...+55	-25...+55	-25...+55
Protection rating	IPX4	IPX4	IPX4	IPX4	IPX4	IPX4
SEC Class	B	B	B	-	-	-
Erp compliance	2018	2018	2018	2018	2018	2018

TURBO EC 100

Sound power level, A-weighted	Total	Octave frequency bands [Hz]								LpA 3 m	LpA 1 m
		63	125	250	500	1000	2000	4000	8000		
LWA to inlet [dBA]	74	42	55	62	70	69	66	58	52	54	63
LWA to outlet [dBA]	69	33	42	59	66	63	62	57	50	49	59
LWA to environment [dBA]	67	27	45	55	65	62	60	49	38	47	57

TURBO EC 125

Sound power level, A-weighted	Total	Octave frequency bands [Hz]								LpA 3 m	LpA 1 m
		63	125	250	500	1000	2000	4000	8000		
LWA to inlet [dBA]	76	36	46	60	75	66	65	61	54	56	66
LWA to outlet [dBA]	74	34	48	61	70	69	64	60	53	53	63
LWA to environment [dBA]	70	33	48	56	68	63	60	52	42	49	59

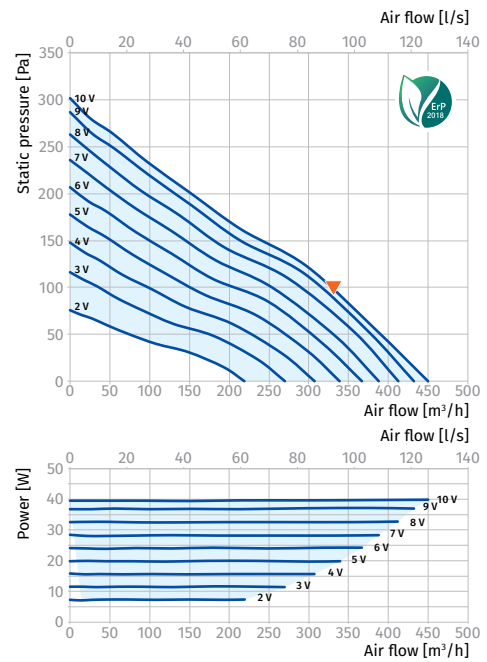
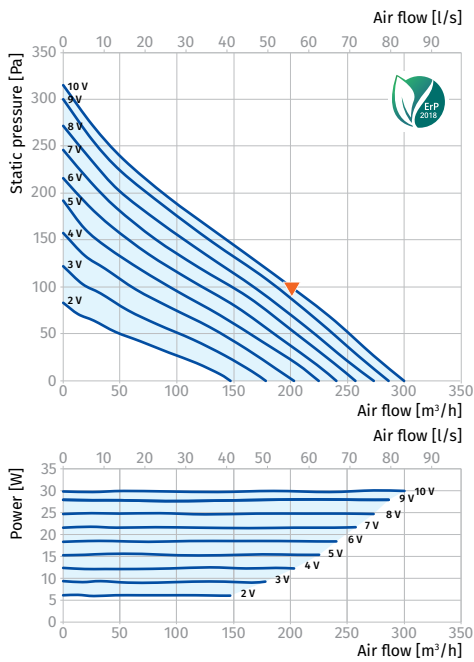

TURBO EC 150 (160)

Sound power level, A-weighted	Total	Octave frequency bands [Hz]								LpA 3 m	LpA 1 m
		63	125	250	500	1000	2000	4000	8000		
LWA to inlet [dBA]	70	37	43	58	65	63	65	59	52	50	60
LWA to outlet [dBA]	68	41	45	52	60	63	63	59	52	47	57
LWA to environment [dBA]	67	32	44	59	63	59	58	51	43	46	56

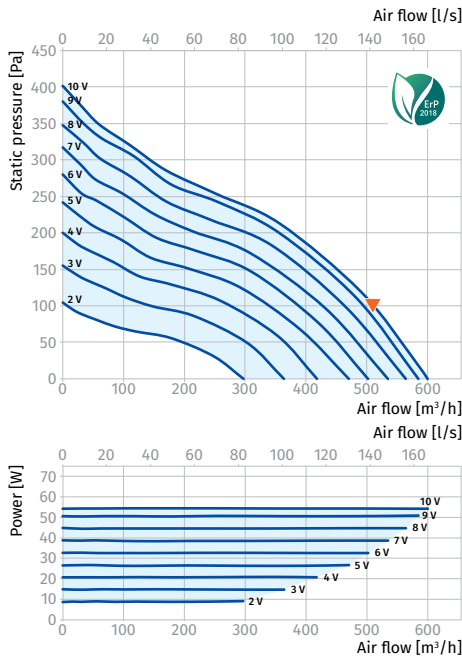

TURBO EC 200

Sound power level, A-weighted	Total	Octave frequency bands [Hz]								LpA 3 m	LpA 1 m
		63	125	250	500	1000	2000	4000	8000		
LWA to inlet [dBA]	76	36	45	57	70	69	72	69	59	56	65
LWA to outlet [dBA]	76	48	49	56	69	71	71	70	60	56	65
LWA to environment [dBA]	69	35	42	54	64	65	65	58	43	49	59

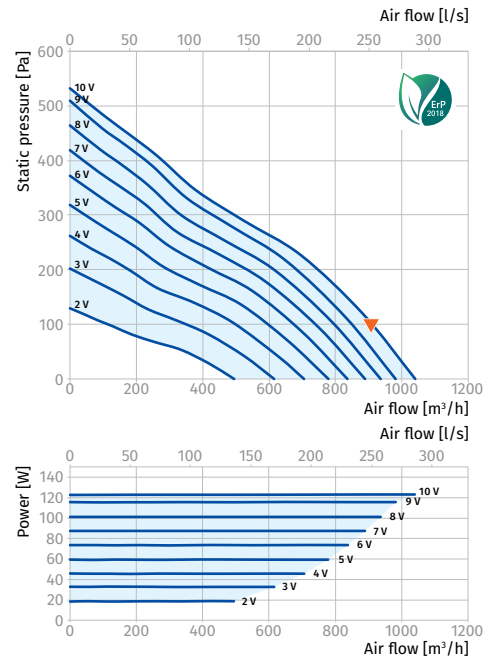

TURBO EC 250

Sound power level, A-weighted	Total	Octave frequency bands [Hz]								LpA 3 m	LpA 1 m
		63	125	250	500	1000	2000	4000	8000		
LWA to inlet [dBA]	81	43	51	64	77	77	77	69	62	61	71
LWA to outlet [dBA]	81	49	54	67	75	78	77	72	62	61	71
LWA to environment [dBA]	73	53	49	56	66	71	68	55	43	53	63

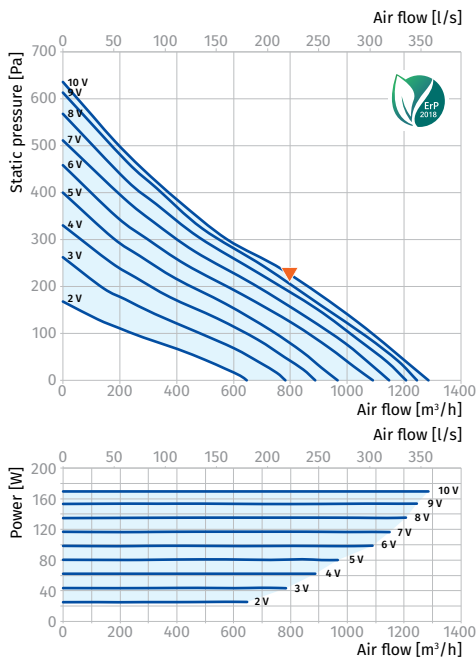

TURBO EC 315

Sound power level, A-weighted	Total	Octave frequency bands [Hz]								LpA 3 m	LpA 1 m
		63	125	250	500	1000	2000	4000	8000		
LWA to inlet [dBA]	81	42	54	64	74	78	75	70	63	61	70
LWA to outlet [dBA]	83	43	54	72	77	78	78	73	66	63	72
LWA to environment [dBA]	75	37	48	60	68	73	68	60	48	55	65

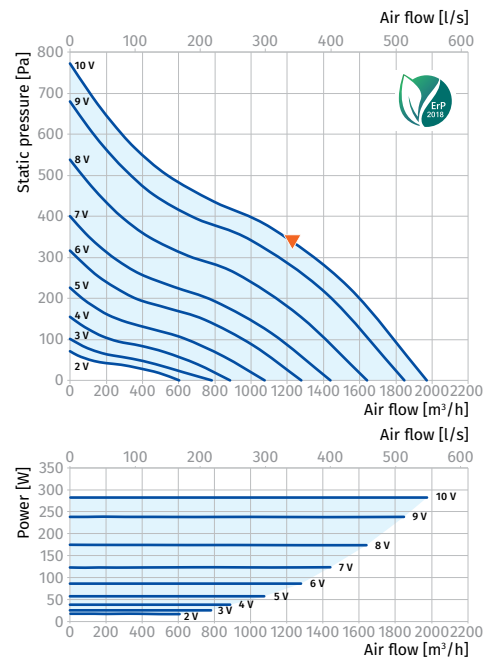

INLINE FANS